

SCHNITTSCHHEMA I - TRÄGER (INP / IPE / HEB / HEA / HEM)

Schnittschema für Gehrungsschnitte

maximal 60°.

Grundriß, Träger von oben betrachtet.

**Bitte bei Bestellung Nummer mit
angeben.**

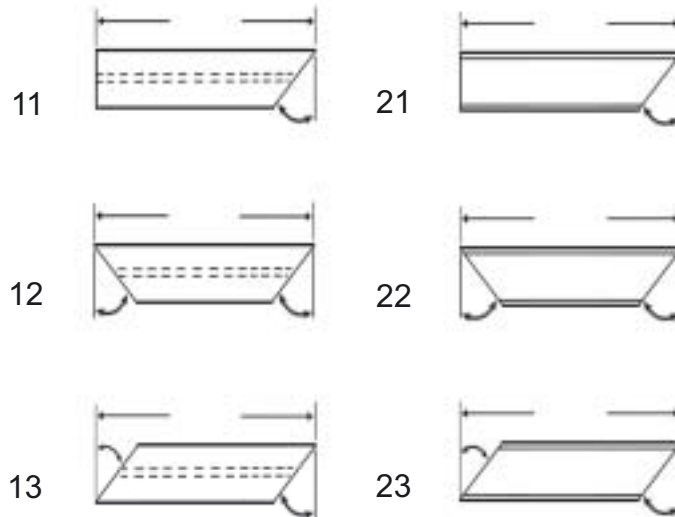

SCHNITTSCHHEMA UNP - TRÄGER

Schnittschema für Gehrungsschnitte

maximal 60°.

Grundriß, Träger von oben betrachtet.

**Bitte bei Bestellung Nummer mit
angeben.**

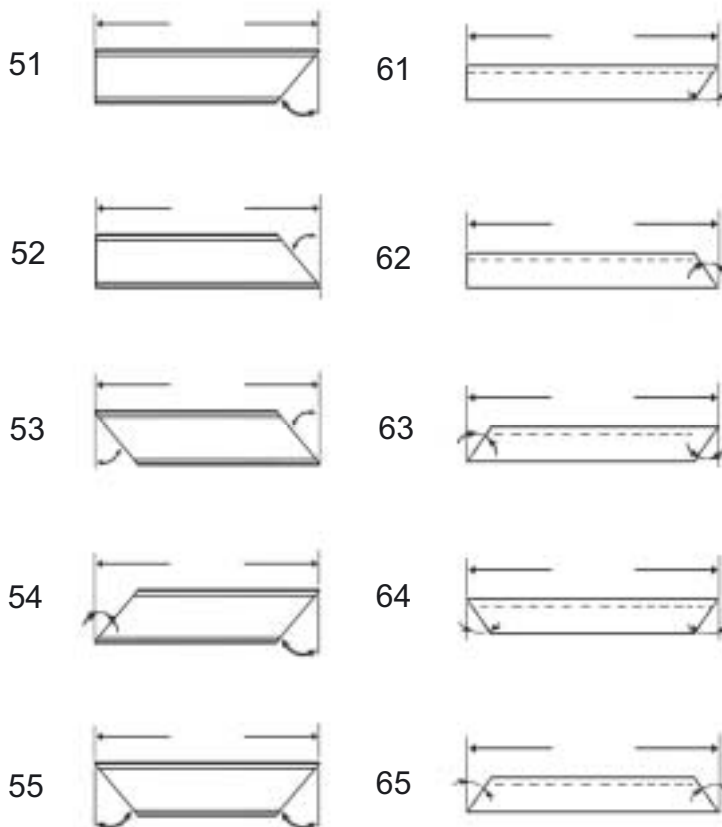

SCHNITTSHEMA FÜR GEHRUNGSSCHNITTE BIS MAX 60°

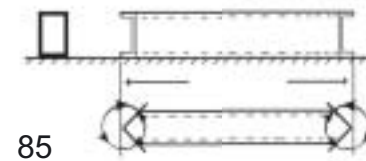
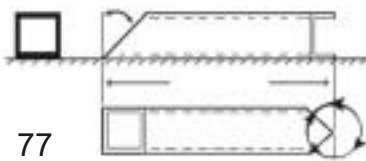
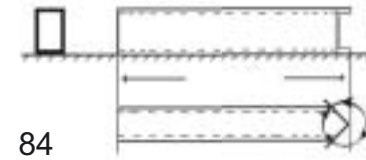
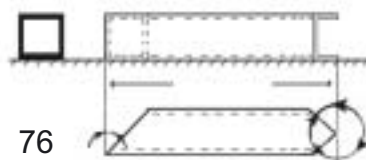
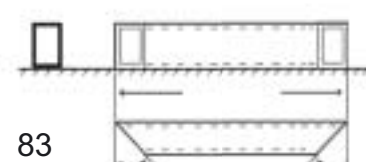
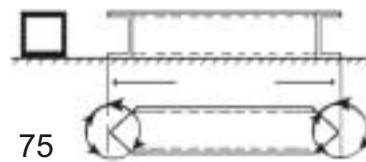
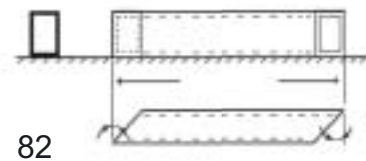
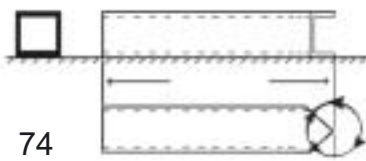
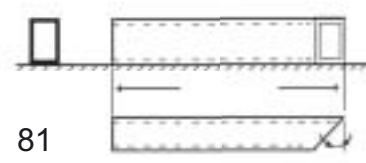
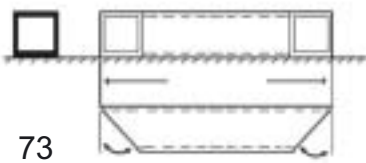
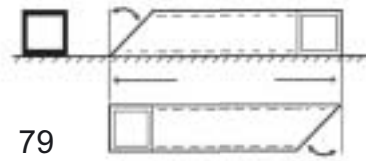
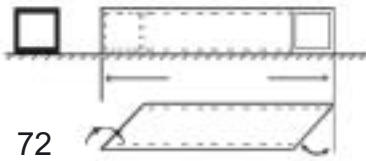
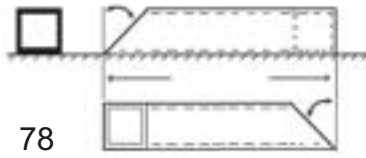
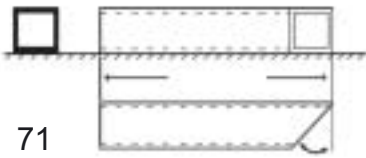

Bitte bei Bestellung Nummer mit angeben.

SCHNITTSHEMA FÜR GEHRUNGSSCHNITTE BIS MAX 60°

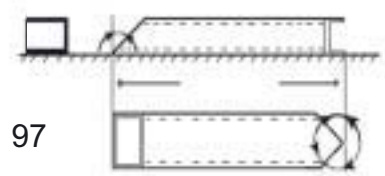
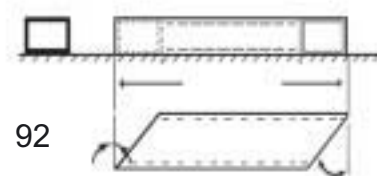
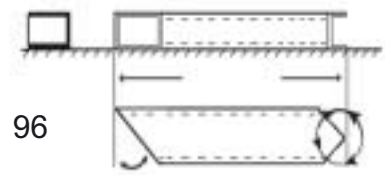
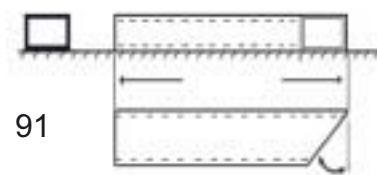
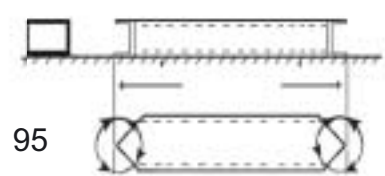
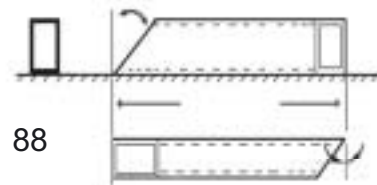
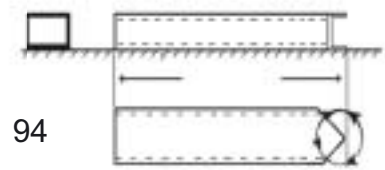
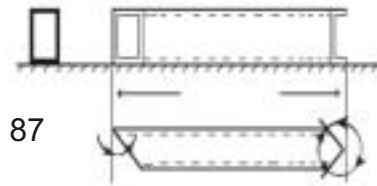
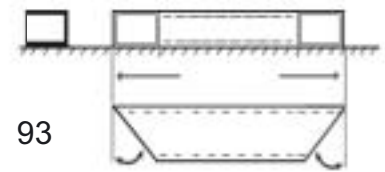
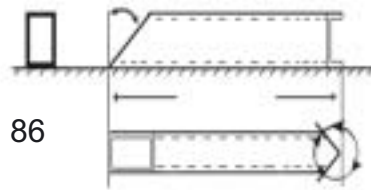

Bitte bei Bestellung Nummer mit angeben.